

Wave Optics

[TOPIC 1] Huygens' Principle

Wave optics describes the connection between waves and rays of light. According to wave theory of light, light is a form of energy which travels through a medium in the form of transverse wave. The wave theory introduces the concept of wavefront.

1.1 Wavefront

The locus of all those particles which are vibrating in the same phase at any instant is called wavefront. Thus, a wavefront is a surface of constant phase.

The shape of wavefront depends on the shape of sources of light. Wavefronts can be of three types. They are as follows:

- (i) Spherical wavefront (ii) Cylindrical wavefront
- (iii) Plane wavefront

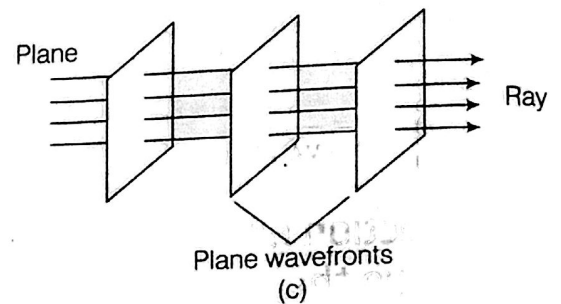
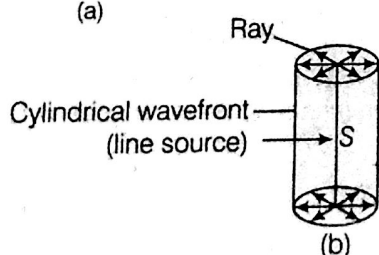
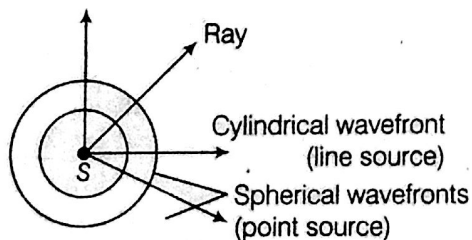

Different types of wavefronts

The speed with which the wavefront moves outwards from the source is called the **phase speed**. The path along which light travels is called **ray of light**. The direction of light rays are always perpendicular to the wavefront and in outwards direction from the source.

1.2 Huygens' Principle

Huygens' principle is essentially a geometrical construction, which gives the shape of the wavefront at any time, allows us to determine the shape of the wavefront at a later time.

According to Huygens' principle,

- (i) Every point on a wavefront behaves like a light source and emits secondary wavelets. The secondary wavelets spread in all directions in space (or given medium) with the velocity of light.
- (ii) The envelope of wavefront of secondary wavelets, after a given time, along forward direction gives the new position of wavefront.

Some important points related to Huygens' principle

- The laws of reflection and refraction can be verified using Huygens' wave theory.
- Huygens' wave theory successfully explains the phenomenon of interference, diffraction and polarisation.
- As, frequency ν is characteristic of the source, therefore $\nu = \frac{1}{T}$ remains the same as light travels from one medium to another.
- Wavelength is inversely proportional to refractive index (μ) of the medium and directly proportional to the phase speed or wave speed. Using the relation i.e. $\nu = v\lambda$,

we get,

$$\frac{\mu_2}{\mu_1} = \frac{v_1}{v_2} = \frac{v\lambda_1}{v\lambda_2} = \frac{\lambda_1}{\lambda_2}$$

Laws of reflection on the basis of Huygens' wave theory

As shown in figure, consider a plane wavefront AB incident on the reflecting surface XY , both the wavefront and the reflecting surface being perpendicular to the plane of paper.

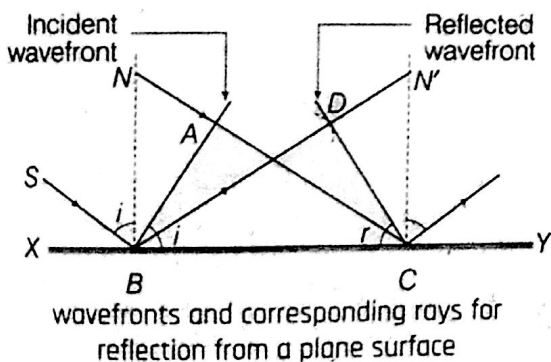

First the wavefront touches the reflecting surface at B and then at the successive points towards C . In accordance with Huygens' principle, from each point on BC , secondary wavelets start growing with the speed c .

During this time the disturbance from A reaches the point C , the secondary wavelets from B must have spread over a hemisphere of radius $BD = AC = ct$, where t is the time taken by the

disturbance to travel from A to C . The tangent plane CD drawn from the point C over this hemisphere of radius ct will be the new reflected wavefront.

Let angles of incidence and reflection be i and r , respectively. In $\triangle ABC$ and $\triangle DCB$, we have

$$\angle BAC = \angle CDB \quad [\text{each is } 90^\circ]$$

$$BC = BC \quad [\text{common}]$$

$$AC = BD \quad [\text{each is equal to } ct]$$

$$\therefore \triangle ABC \cong \triangle DCB$$

$$\text{Hence } \angle ABC = \angle DCB \text{ or } i = r$$

i.e. the angle of incidence is equal to the angle of reflection. This proves the first law of reflection.

Further, since the incident ray SB , the normal BN and the reflected ray BD are respectively perpendicular to the incident wavefront AB , the reflecting surface XY and the reflected wavefront CD (all of which are perpendicular to the plane of the paper) therefore, they all lie in the plane of the paper i.e. in the same plane. This proves the second law of reflection.

Law of refraction on the basis of Huygens' wave theory

Consider a plane wavefront AB incident on a plane surface XY , separating two media 1 and 2, as shown in figure. Let v_1 and v_2 be the velocities of light in two media, with $v_2 < v_1$.

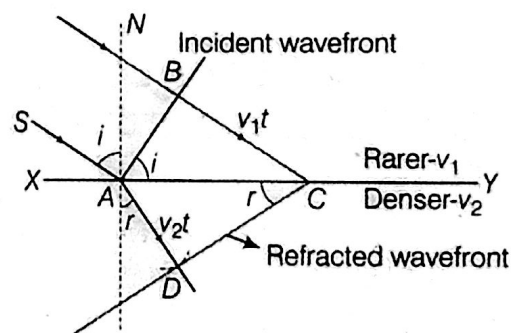

The wavefront first strikes at point A and then at the successive points towards C . According to Huygens' principle, from each point on AC , the secondary wavelets starts growing in the second medium with speed v_2 . Let the disturbance takes time t to travel from B to C , then $BC = v_1t$.

During the time the disturbance from B reaches the point C , the secondary wavelets from point A must have spread over a hemisphere of radius $AD = v_2 t$ in the second medium. The tangent plane CD drawn from point C over this hemisphere of radius $v_2 t$ will be the new refracted wavefront.

Let the angles of incidence and refraction be i and r , respectively.

From right $\triangle ABC$, we have, $\sin \angle BAC = \sin i = \frac{BC}{AC}$

From right $\triangle ADC$, we have, $\sin \angle DCA = \sin r = \frac{AD}{AC}$

$\therefore \frac{\sin i}{\sin r} = \frac{BC}{AD} = \frac{v_1 t}{v_2 t}$

or $\frac{\sin i}{\sin r} = \frac{v_1}{v_2} = {}^1\mu_2$ (a constant)

This proves **Snell's law of refraction**. The constant ${}^1\mu_2$ is called the refractive index of the second medium with respect to first medium.

Further, since the incident ray SA , the normal AN and the refracted ray AD are respectively

perpendicular to the incident wavefront AB , the dividing surface XY and the refracted wavefront CD (all perpendicular to the plane of the paper), therefore, they all lie in the plane of the paper, i.e. in the same plane. This proves another law of refraction.

Behaviour of a Prism, Lens and Spherical Mirror towards Plane Wavefront

There are following behaviour of a prism, lens and spherical mirrors towards plane wavefront

Behaviour of a Prism

Emerging wavefront will be tilted.

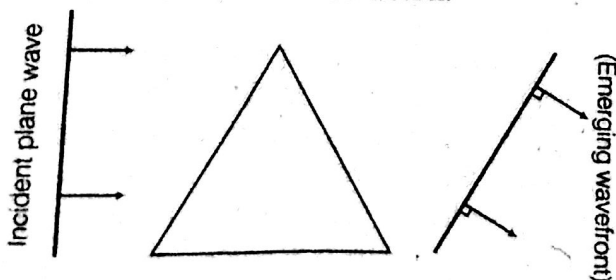

Behaviour of a Lens

Emerging wavefront will be spherical.

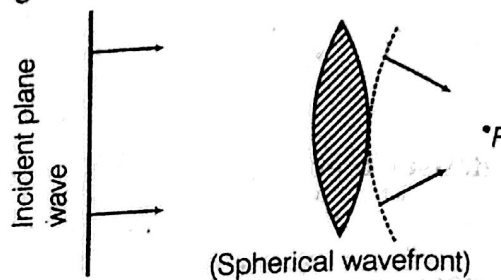

Behaviour of a Spherical Mirror

Reflected wavefront will be spherical.

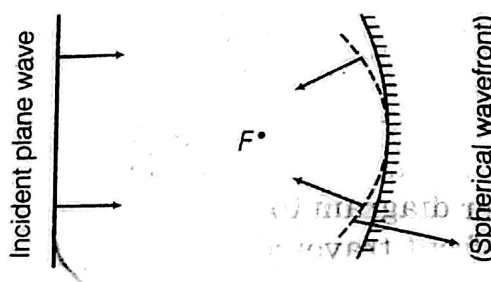

[TOPIC 2] Interference of Light

2.1 Superposition Principle

According to superposition principle at a particular point in the medium, the resultant displacement y produced by a number of waves is the vector sum of the displacements produced by each of the waves (y_1, y_2, y_3, \dots)

i.e.

$$y = y_1 + y_2 + y_3 + \dots$$

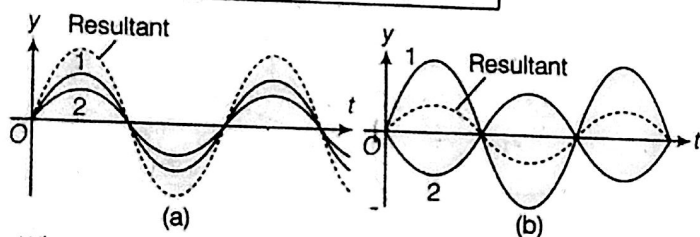

When two or more than two waves superimpose over each other at a common particle.

- (ii) The amplitude of electric field vector of interfering wave should be equal to have greater contrast.

2.2 Interference of Light Waves

The phenomenon of redistribution of energy in the region of superposition of waves is called **interference**. The points of maximum intensity in the regions of superposition of waves are said to be in **constructive interference** whereas the points of minimum intensity are said to be in **destructive interference**.

Two waves of amplitudes a_1 and a_2 interfere at a point where phase difference is ϕ , then resultant amplitude is given by $A^2 = a_1^2 + a_2^2 + 2a_1a_2 \cos \phi$

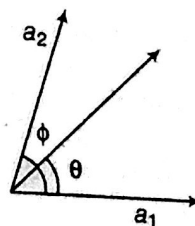

For constructive interference, $A_{\max} = (a_1 + a_2)^2$

For destructive interference, $A_{\min} = (a_1 - a_2)^2$

Also, resultant intensity, $I = I_1 + I_2 + 2\sqrt{I_1 I_2} \cos \phi$

When $I_1 = I_2 = I_0$, then resultant intensity,
 $I = I_0 + I_0 + 2I_0 \cos \phi = 2I_0 (1 + \cos \phi)$

$$I = 4I_0 \cos^2 (\phi/2)$$

Coherent and Incoherent Sources

Coherent sources of light are those sources of light which emit light waves of same frequency, same wavelength and have a constant phase difference.

Coherent source of light can be obtained by deriving two sources from a primary (or initial) source by

- (i) division of wavefront (ii) division of amplitude

Two sources of light, which do not emit light waves with a constant phase difference are called **incoherent sources**.

Conditions for sustained interference

- (i) The two sources of light must be coherent.

Conditions for Constructive Interference

If initial phase difference is zero, then the interference waves must have

- (i) phase difference = $2n\pi$, where, $n = 1, 2, 3, \dots$
- (ii) path difference = $n\lambda$, where, $n = 1, 2, 3, \dots$

$$I_{\max} \propto (a_1 + a_2)^2$$

Conditions for Destructive Interference

Assuming initial phase difference = 0

Necessary conditions for interference of waves

- (i) phase difference = $(2n - 1)\pi$,
where, $n = 1, 2, 3, \dots$

- (ii) path difference = $(2n - 1)\frac{\lambda}{2}$,
where, $n = 1, 2, 3, \dots$

$$I_{\min} \propto (a_1 - a_2)^2$$

2.3 Young's Double Slit Experiment

In Young's double slit experiment,

- (i) **Fringe width** of bright and dark fringe

$$\beta = \frac{D\lambda}{d}$$

where, λ = wavelength of wave,
 D = distance between slit and screen
and d = distance between two slits

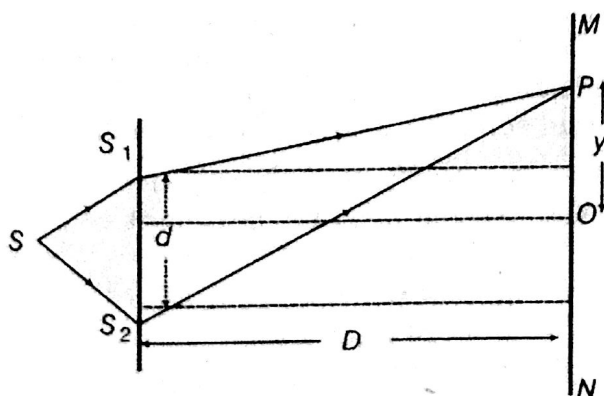

Young's arrangement to produce interference pattern

$$\text{Angular fringe width, } \theta = \frac{\beta}{D} = \frac{\lambda}{d}$$

- (ii) Separation of n th order bright fringe from central fringe

$$y_n = \frac{Dn\lambda}{d}, \text{ where, } n = 1, 2, 3, \dots$$

- (iii) Separation of n th order dark fringe from central fringe

$$y_n = (2n - 1) \frac{D\lambda}{2d}, \text{ where, } n = 1, 2, 3, \dots$$

- (iv) Angular position of n th order

(a) Bright fringe = $\frac{y_n}{D} = \frac{n\lambda}{d}$

(b) Dark fringe = $\frac{y_n}{D} = (2n - 1) \frac{\lambda}{2d}$

where, $n = 1, 2, 3, \dots$

- (v) Fringe width decreases, when whole apparatus is taken from air to a denser medium, due to the decrease in wavelength of the light.

Distribution of Intensity

The distribution of intensity in Young's double slit experiment is shown below

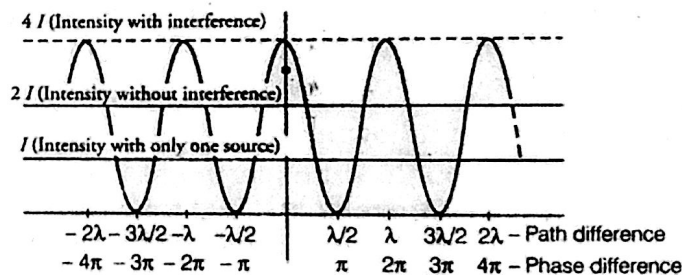

Some important points related to distribution of intensity

- **Intensity of Light (I)** is proportional to the width (d) of slit and ratio of slit-width (a).

$$d_1/d_2 = I_1/I_2 = a_1^2/a_2^2$$

- Ratio of maximum and minimum intensity of light $I_{\max}/I_{\min} = (a_1 + a_2/a_1 - a_2)^2 = (r + 1/r - 1)^2$

where, $r = a_1/a_2 = \sqrt{I_1/I_2}$

- A coloured fringe pattern is obtained with central white fringe when monochromatic light is replaced by white light.

- If refracting slab of thickness t is placed in front of one of the two slits of YDSE, then fringe pattern get shifted by n fringe is given by $(\mu - 1) t = n\lambda$
- If both slits are covered by refracting surfaces of thicknesses t_1 and t_2 and refractive indices μ_1 and μ_2 , then fringe pattern gets shifted by n fringe is given by $(\mu_2 - \mu_1)t = n\lambda$

[TOPIC 3] Diffraction and Polarisation of Light

3.1 Diffraction of Light

The phenomenon of bending of light around the sharp corners and the spreading of light within the geometrical shadow of the opaque obstacles is called diffraction of light.

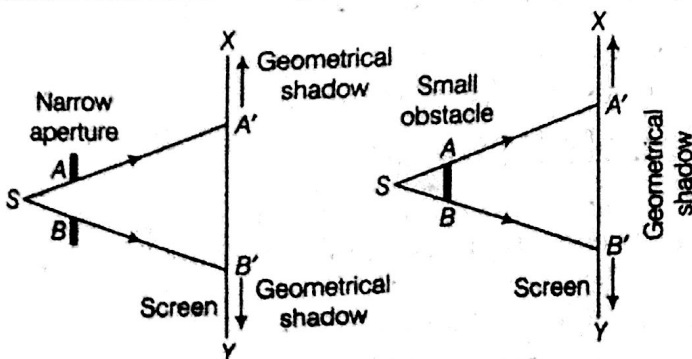

Diffraction of light around corners of (a) a small aperture (b) a small object.

For most pronounced diffraction dimension of aperture or the obstacle should be comparable to the wavelength of light.

Diffraction due to a Single Slit of Width d

A parallel beam of light with a plane wavefront WW' is made to fall on a single slit AB . Width of the slit is of the order of wavelength of light, therefore, diffraction occurs on passing through the slit. As shown in the diagram below.

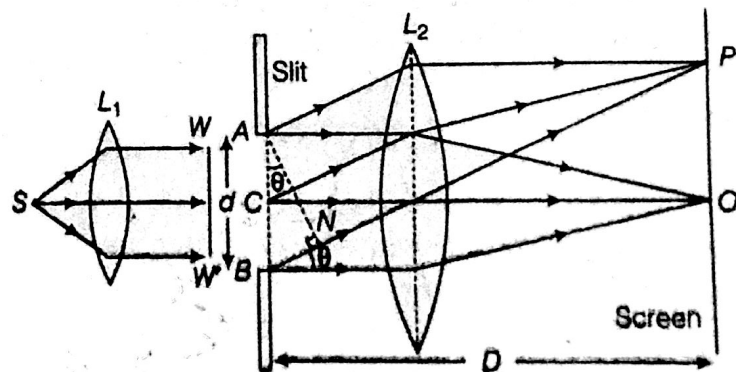

Resolving Power of Optical Instruments

Resolving power of an optical instrument is the ability of the instrument to produce distinctly separate images of two close objects.

(i) Resolving power of microscope

$$= \frac{1}{\Delta d} = \frac{2\mu \sin \beta}{\lambda}$$

(ii) Resolving power of a telescope = $\frac{1}{d\theta} = \frac{D}{1.22\lambda}$



$d\theta$ = angle subtended by the two distinct objects of objective.

β = half angle of cone of light from the point object.

D = diameter of the objective.

Difference between the interference pattern and the diffraction pattern

Characteristics	Interference	Diffraction
Fringe width	All bright and dark fringes are of equal width.	The central bright fringe have got double width to that of width of secondary maxima or minima.
Intensity of bright fringes	All bright fringes are of same intensity.	Central fringe is the brightest and intensity of secondary maxima, decreases with the increase of order of secondary maxima on either side of central maxima.

Diffraction at a Circular Aperture

Angular spread of central maxima = $1.22\lambda/d$,

Linear spread = $D\theta'$, Areal spread = $D^2 \theta^2$

Fresnel's Distance

The distance at which the diffraction spread of a beam is equal to the size of the aperture is called Fresnel's distance.

i.e., when linear width = d

$$D = D_F$$

$$\therefore d = \frac{D_F \lambda}{d} \quad \text{or} \quad D_F = \frac{d^2}{\lambda}$$

The ray optics is applicable, when $D < D_F$.

(i) n th order secondary minima is obtained when $d \sin \theta = n\lambda$, where, $n = 1, 2, 3, \dots$

(ii) n th order secondary maxima is obtained when

$$d \sin \theta = (2n + 1) \frac{\lambda}{2},$$

where, $n = 1, 2, 3, \dots$

(iii) Angular separation for n th minima,

$$\theta_n = \frac{n\lambda}{d},$$

where, $n = 1, 2, 3, \dots$

(iv) Linear separation of n th secondary minima, $y_n = \frac{Dn\lambda}{d}$

(v) Angular position of n th order secondary maxima, $\theta_n = (2n + 1) \frac{\lambda}{2d}$, D = distance of screen from single slit

(vi) Angular width of central maxima = $\frac{2\lambda}{d}$

(vii) Linear width of central maxima, $\beta_0 = \frac{2D\lambda}{d}$

(viii) Angular width of secondary maxima or minima = $\frac{\lambda}{d}$

(ix) Linear width of secondary maxima or minima (β) = $\frac{D\lambda}{d}$

Clearly ($\beta_0 = 2\beta$)

(x) Intensity of central maxima is maximum and intensity of secondary maxima decreases with the increase of their order. The diffraction pattern is graphically shown alongside.

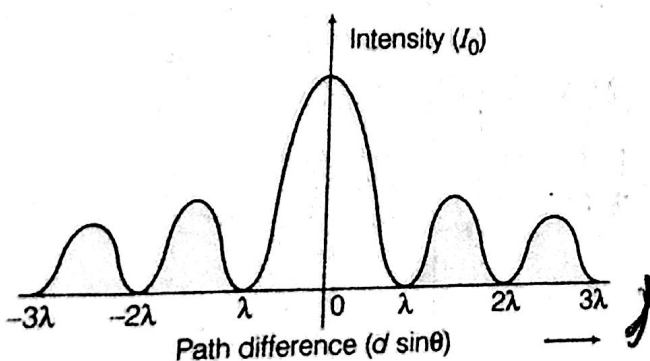

3.2 Polarisation

The phenomenon of restricting the vibrations of light in a particular direction, perpendicular to the direction of wave motion is called **polarisation of light**. Polarisation ensures the transverse nature of light.

Polarisers A device that plane-polarises the unpolarised light passed through it is called a polariser. e.g., Tourmaline, crystal, nicol prism, polaroid.

Malus' Law

According to law of Malus', when a beam of completely plane polarised light is incident on an analyser, the resultant intensity of light (I) transmitted from the analyser varies directly as the square of the cosine of the angle θ between the plane of transmission of analyser and polariser.

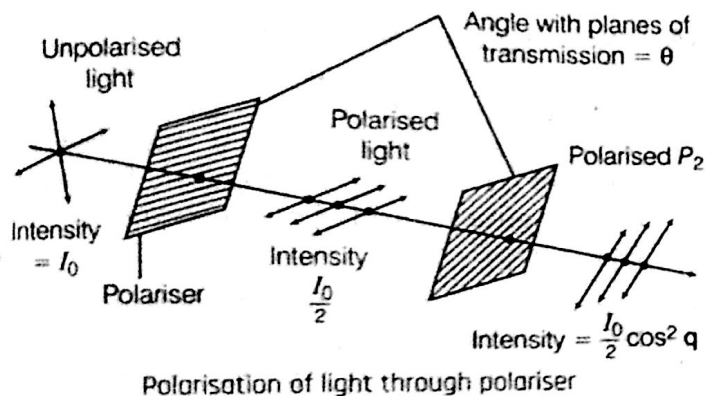

i.e.

$$I \propto \cos^2 \theta \Rightarrow I = I_0 \cos^2 \theta$$

This rule is also called **cosine square rule**.

where, I_0 = intensity of plane polarised light after passing through P_1 .

Brewster's Angle and Brewster Law

- (i) The angle of incidence at which the reflected light is completely plane polarised is called polarising angle or Brewster's angle (i_B).
- (ii) According to this law, when unpolarised light is incident at polarising angle, i_B on an interface separating air from a medium of refractive index μ , then the reflected light is

plane polarised (perpendicular to the plane of incidence), provided, $\mu = \tan i_B$

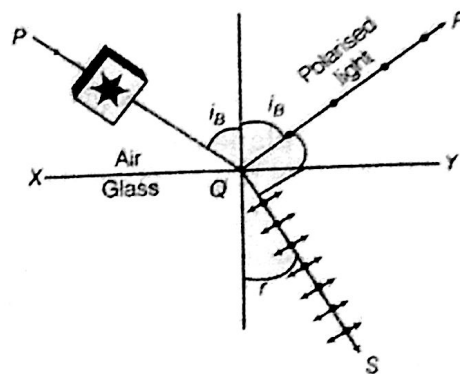

Polarisation by reflection

where, i_B = Brewster's angle and μ = refractive index, $i_B + r = 90^\circ$, i.e. reflected plane polarised light is at right angle from refracted light.

From Snell's law,

$$\mu = \frac{\sin i_B}{\sin r_B} = \frac{\sin i_B}{\sin (90 - i_B)} = \frac{\sin i_B}{\cos i_B} = \tan i_B$$

Polaroids

Polaroids are the commercial devices to produce plane polarised light making use of selective absorption. Polaroids are used in sunglasses, wind screen, window panes of aeroplane and to make the 3-D movies to make images vivid and clear. Modes of production of plane polarised light are below:

- (i) Reflection (Brewster's law)
- (ii) Scattering
- (iii) Double refraction (calcite)
- (iv) Selective absorption (dichroism)